

For professional use only. Please refer to the conditions of use of our catalogue.

March 2002

2GRE35 160x62R code Q07-17

Voltage	Frequency	Input power	Current	Capacitor	Air flow	Rotational speed	Sound level	Direction of rotation	Max. Air temp.
V	Hz	Wa	A	µF	m ³ /h	rpm	dBA	↻	°C
230	50	159	0,70	4	475	1660	58	R	-20 / +50
230	60	162	0,73	3,5	400	1460	56	R	-20 / +50

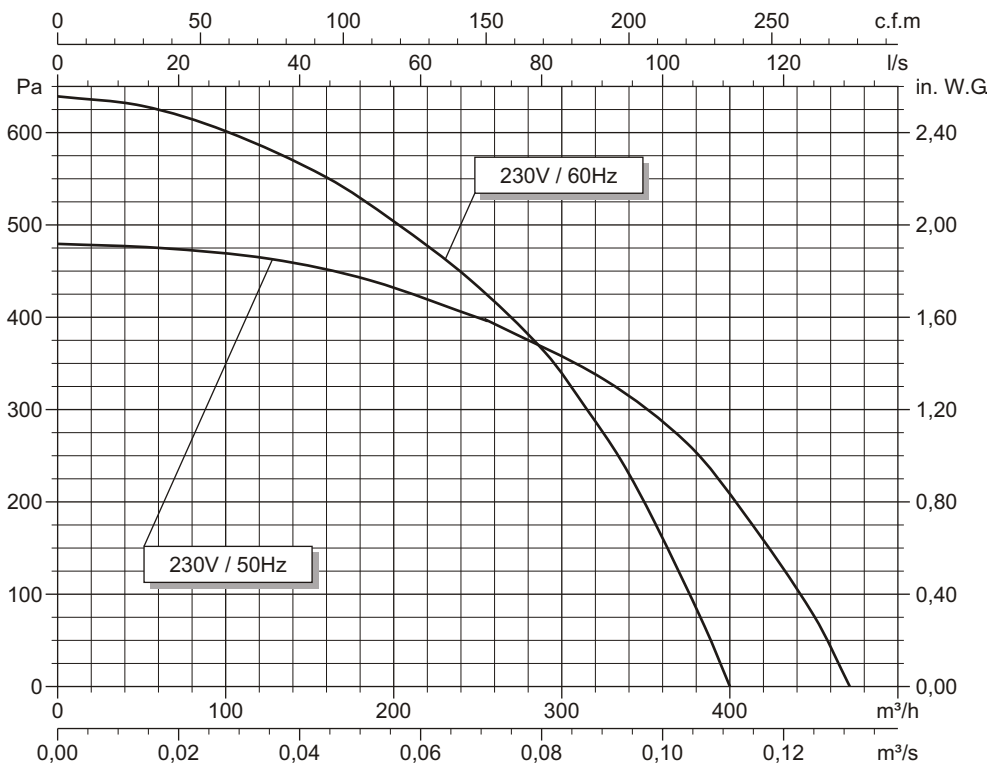
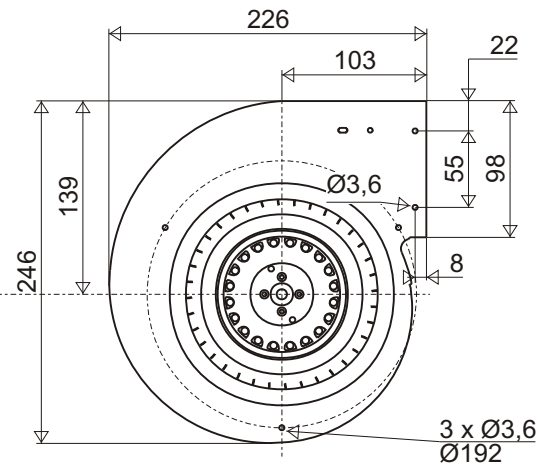
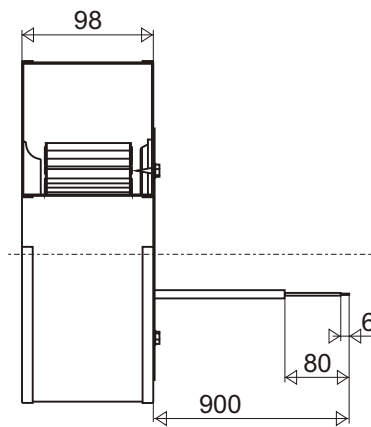

- Ball bearings.
- Cl.F windings protected by thermal cut-out.
- Protection IP 44.
- Balancing G2.5.
- Galvanised steel impeller.
- Steel painted black scroll.

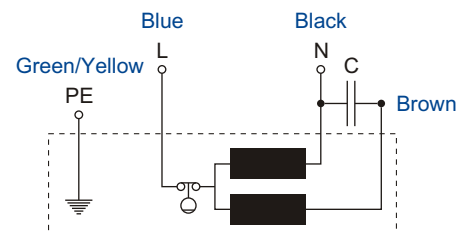

Capacitor for 50Hz	Capacitor for 60Hz	Finguer guard	Inlet cone
19019-0	19049-0	21325-0	16154-0